

Since 1968

COMMAX
SmartHome & Security

User Manual

Color Video Door Phone CAV-43MHG / CAV-43MHG(M)



www.commax.com

COMMAX Co.,Ltd.



- Thank you for purchasing COMMAX products.
- Please carefully read this User's Guide (in particular, precautions for safety) before using a product and follow instructions to use a product exactly.
- The company is not responsible for any safety accidents caused by abnormal operation of the product.



Table of Contents

1. Greeting	1
2. Warnings and caution	2
3. Part names and functions	4
4. Usage instruction	4
5. User Setting	7
6. System Setting	10
7. How to use lobby phone	11
8. Installation	12
9. Wiring method	12
10. Component	14
11. Specifications	14











1. Greeting

- Thank you for purchasing a COMMAX product
- Please, use the product after carefully reading this Manual
- This type of videophone can be used in apartments, villas and other buildings as a multifunctional device with door opening, telephone conversation and guard station control function











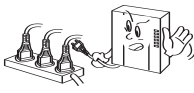

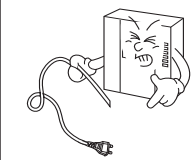



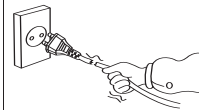





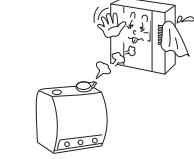

2. Warnings and caution

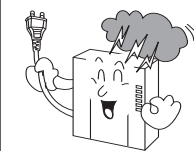
Please follow the things described below in order to prevent any danger or property damage.

	<p>Warning It may cause a serious damage or injury if violated.</p>		<p>Prohibition.</p>
	<p>Caution It may cause a minor damage or injury if violated.</p>		<p>No disassembly</p>
			<p>No touch</p>
			<p>Must follow strictly.</p>
			<p>Shows plugging out the power cord without an exception</p>
			<p>Shows the warning and caution for an electric shock.</p>
			<p>Shows the warning and caution for a fire.</p>

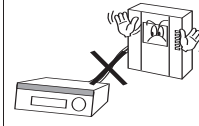
Warning

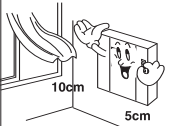
Power & Installation

<p>Please don't use several products at the same time on one power socket.</p> <ul style="list-style-type: none"> It may cause a fire due to an abnormal overheating.  <p>   </p>	<p>Please don't bend the power cable excessively or it may cause an electric shock.</p> <ul style="list-style-type: none"> fire when using a damaged power cable.  <p>    </p>	<p>Please don't handle the power cable with a wet hand.</p> <ul style="list-style-type: none"> It may cause an electric shock.  <p>   </p>	<p>Please plug out the power cable from the socket when not using it for a long period of time.</p> <ul style="list-style-type: none"> It may shorten the product lifespan or cause a fire.  <p>   </p>
<p>Please don't install the product in the place where there is much oil, smoke or humidity.</p> <ul style="list-style-type: none"> It may cause an electric shock or fire.  <p>    </p>	<p>Please don't install the product with the lightning and thunder.</p> <ul style="list-style-type: none"> It may cause an electric shock or fire.  <p>    </p>	<p>Please don't use and connect this product with other products with different rated voltage.</p> <ul style="list-style-type: none"> It may cause a disorder or fire.  <p>   </p>	<p>When installing the product that generates heat, please install the product away from the wall (10cm) for the ventilation.</p> <ul style="list-style-type: none"> It may cause a fire due to the increased internal temperature.  <p>   </p>

⚠ Warning

Cleaning & Use

Please don't disassemble, repair or rebuild this product arbitrarily (please contact the service center if a repair is needed).

- It may cause an electric shock or fire.

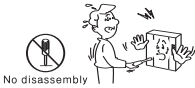

If an abnormal sound, burning smell or smoke is coming out of the product, please plug out the power cable and contact a service center.

- It may cause an electric shock or fire.

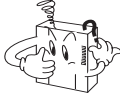

Please don't insert any metallic or burnable materials into the ventilation hole.

- It may cause an electric shock or fire.



Please use only the designated batteries for the products of using DC power.

- It may cause an electric shock or fire.



⚠ Caution

Power & Installation

Please plug the power cable firmly into the inner end.

- It may cause a fire.

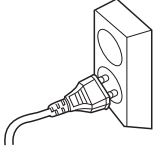

Please hold the plug tightly when unplugging the power cable (a part of the copper wire may be disconnected if the grabbing is only made on the cord when pulling out the cable).

- It may cause an electric shock or fire.



When connecting the power cables after cutting the cable, please install the product with power off.

- It may cause an electric shock or fire.



When installing the product, please fix it firmly while using the wall-mounting unit and screws.

- It may cause an injury from the falling object.

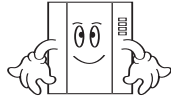

Please be careful when using an AC circuit breaker since there is a possibility of an electric shock.

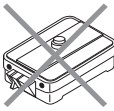

Please check the use voltage and current for the DC-only products and use the appropriate rectifier.

- It may cause a fire.



Please avoid direct rays of the sun or heating devices at a time of installation.

- It may cause a fire.

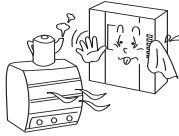

Please don't install the product on an unstable place or small support board.

- It may cause an injury if it falls down while in use.

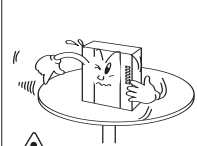

Cleaning & Use

When cleaning the product, please rub it with a soft and dry cloth after plugging out the power cable. (Please don't use any chemical products such as wax, benzene, alcohol or cleanser.)



Please don't drop the product on the ground and don't apply a shock.

- It may cause a failure.

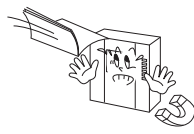

Please use the designated connection cable within the maximum calling distance designated for the product.

- It may reduce the product performance.





3. Part names and functions

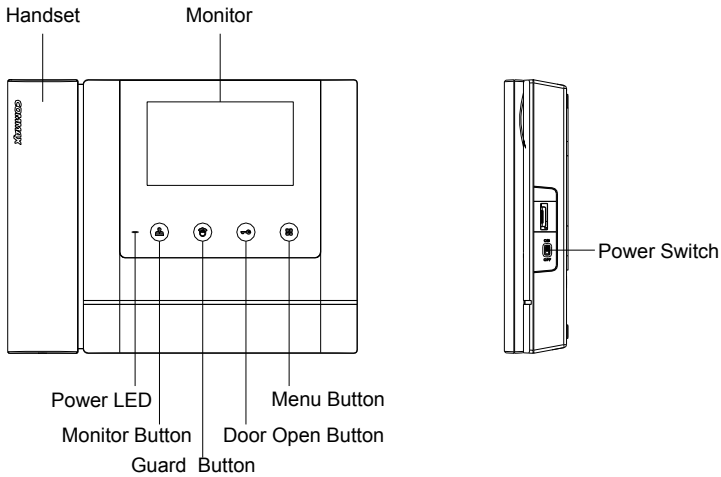

4. Usage instruction

※ Caution : When you are holding the handset while the hook switch is off and someone may push the button of camera, you may lose your hearing because of high volume of calling sound.

4-1. Call from the individual entrance

- ① When the visitor presses the call button, an electronic chime sound rings and the visitor's image appears on the monitor.
- ② By picking up the handset, you can talk with the visitor. If you press door release button, door will be released.
(Door release works only while talking and it is possible only when the door camera is interlocked with door release function.)
- ③ When you receive the call from (Lobby / Guard Station) during the conversation with the individual entrance, the electronic chime sound rings. Then, press the (Lobby: monitoring button / Guard Station: guard button) from the video phone to finish the conversation with the individual entrance and have a conversation with (Lobby / Guard Station).
- ④ Screen will be turned off after 60 sec automatically, press the monitoring button to check again.
- ⑤ If you put down the handset, talking is finished and turns to stand-by mode.

4-2. Call from the Lobby

- ① Visitor's image will be shown on the monitor with emitting chime sound when a visitor presses the call button.
- ② By picking up the handset, you can talk with the visitor.
(Screen will be turned off after 60 sec automatically from the beginning of conversation)
- ③ When you receive the call from individual entrance during the conversation with Lobby, the electronic chime sound rings. Then, press the monitoring button from the video phone to finish the conversation with lobby and have a conversation with visitor.
- ④ When you press the door release button in the middle of conversation, the lobby gate will be opened with switchgear sound and the conversation will be finished.

4-3. Conversation with Guard

(1) Call from the guard

- ① The sound of call will be emitted when it has a call from guard.
- ② By picking up the handset, you can talk with the guard.
- ③ If there is a call from door while you are communicating to a person at guard station, it chimes and the image of visitors is shown. Then, press the monitoring button from the video phone to finish the conversation with guard and have a conversation with visitor

(2) Calling the guard station

- ① You can talk with guard station by picking up the handset and pressing guard call button.
- ② Conversation will begin when a guard station responds.

4-4. Monitoring.

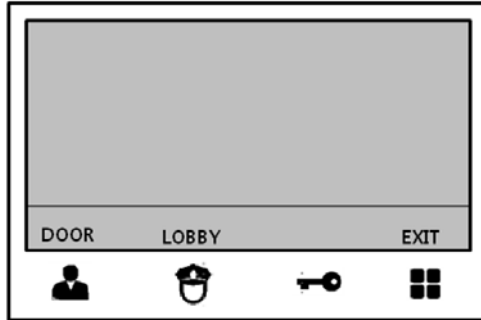

When you receive initial call , your device automatically searches for the door camera and displays OSD accordingly

Display with Door camera

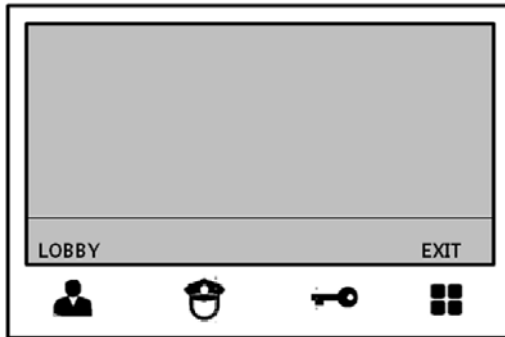

Display with no Door camera



By pressing monitor button, display above appears. If you press button of your desired space (monitoring[], guard[]), you can monitor according space. (Door, Lobby,)



- Monitoring (DOOR/LOBBY)function time is 30secs
- You can talk by picking up the handset while monitoring(DOOR/LOBBY)
- You can monitor only certain lobby with pre-set ID



5. User Setting

•After Menu screen appears, you can change setting with below 4 buttons

Menu start and finish : [] (Menu button -'[]')

SELECT : [] (Guard button -'[]')

Move upward /move right : [] (Door release button -'▲' / '▶')

Move downward /move left : [] (Monitor button -'▼' / '◀')

After pressing MENU button in Video call or monitoring mode, you can change settings for DOOR(LOBBY), VIDEO SET(BRIGHTNESS / CONTRAST/ COLOR), UTILITY (ADDITIONAL FUNCTION) and INFORMATION (product information)

5-1. Display setting

DOOR(LOBBY) VIDEO SET (BRIGHTNESS / CONTRAST/ COLOR control function).

After moving to menu with MENU button, press SELECT button to move to the menu below.

(you can control LOBBY VIDEO SET while you are talking with lobby.)

(1) BRIGHTNESS : control BRIGHTNESS

(2) CONTRAST : control CONTRAST

(3) COLOR : control COLOR

You can control from 0 to 20 level. Initial level is set for level 10

※ how to set

After moving to menu with your desired MENU from 'DOOR VIDEO SET', press SELECT button to move to the menu below

(you can control 'LOBBY VIDEO SET' while you are talking with lobby.)

(4) RESET: reset display setting

※ how to set

After moving to RESET from DOOR VIDEO SET, press SELECT button for RESET.

Select YES with move button.

Complete your setting by pressing SELECT button

※ Notice :Display control and reset function adjusts each video(DOOR/LOBBY) collectively

(5) EXIT: Return to EXIT of initial menu

5-2. UTILITY(additional function)

After moving to MENU with MENU button, press SELECT button to move to below screen.

(1) CHIME-BELL VOLUME : control ringing tone

You can control from 0(MUTE) to 3 level. Initial level is set for level 2.

※ how to set

After moving to CHIME-BELL VOLUME from UTILITY, press SELECT button for CHIME-BELL VOLUME.

Select your desired setting.

Complete your setting by pressing SELECT button.

(2)SCREEN MODE: set display ratio

※ how to set

After moving to SCREEN MODE from UTILITY, press SELECT button for SCREEN MODE.

With ▲/▼ button, select your desired setting.

Complete your setting by pressing SELECT button.

♣ ZOOM :4:3 display is changed into full display mode (default)

♣ 4:3 : actual ratio of camera.

♣ WIDE : display is changed into 16:9 display mode

(3)EXIT: Return to EXIT of initial menu

☞Tip: ringing tone simple volume control function

While you are calling or monitoring, there appears volume control icon on the screen. You can control ringing tone volume by pressing door open button.



Ringing tone volume control(door open button): Every time you press button once,

Ringing tone changes 0 ~3 stages. Control your desired volume by pressing button several times.

(The changed volume is reflected immediately. The according setting screen disappears automatically.)

5-3. INFORMATION(product information)

After entering to menu by pressing menu button, you can move to INFORMATION and check product information

- (1) MODEL : Shows product name
- (2) VERSION : Shows program version
- (3) HOME ID : Shows current building No. / Household No
- (4) TOUCH : Shows touch program version
- (5) VIDEO : Shows current camera output standard. (NTSC / PAL)
- (6) SOURCE : This indicates location of current video
(Household door unit & Lobby entrance)

5-4. EXIT



6. System Setting

You can set HOME SET(Household information setting) and INFORMATION(Product information check) after pressing menu button for 3 seconds in stand by mode.

6-1. HOME SET (Household information entry)

Move to HOME SET from System setting mode and select below

(1) HOME ID : Setting Building No. and Household No

※ How to set

- ① Move to HOME ID from HOME SET and select
- ② After selecting the number with ► / ◀, press the SELECT button and fill it in from first. : Default on household no is 8 digit numbers. Blanks are marked with 0.
(ex : Building no : 101 Household no : 1 (0101 - 0001))

※ Wrong number can be modified with ◀ button.

- ③ When finish inputting 8-digit number, press the select button to save it.

(2) PASSWORD :Setting Household Password

※ How to set

- ① Move to PASSWORD section from HOME SET and select below
- ② Enter numerical numbers by using moving button (Initial building/household No. are set "1234". You should change password to use)

※ Warning : For security reason, do not use repeated No

※ Numbers such as 0000, 1234, 4321 are prohibited to use for security reason

(3) LOBBY ID : Set Lobby entrance ID to monitor

※ How to set

- ① Move to LOBBY ID section from HOME SET and select below
- ② Enter numerical numbers out of 01~39 by using moving button
(Initial Lobby entrance ID No. is set "01")
- ③ Complete setting by pressing "select" button

EXIT : Go back to system setting

6-2. INFORMATION(product information)

In MENU mode, move to INFORMATION and check out Product Information

- (1) MODEL : Product Name
- (2) VERSION : Product Version
- (3) HOME ID : Currently set Building No. & Household No.
- (4) TOUCH : Touch program Version

6-3. EXIT



7. How to use lobby phone

1) When paging the household

- Enter the household number you want to cal.1
ex) household 101⇒1, 0, 1
- Household number appears on FND
- Press the Call button (E)
- Conversation begins when they answer.

2) When paging guard station

- Press the guard button
- 'gUAd' appears on FND
- Press the Call button (E)
- Emit call house along with flickering of 'gUAd'.
- Conversation begins when guard station answers.

3) Opening the door with RF card

- Press the Household number
- Press the Key button (K)
- Letters of 'PASS' flicker on the FND.
- Press the 4-digit password.
- Appears '----' on the FND.
- Press the Call button
- Door is open with flickering of 'oPEn' on FND .

[Reference for use]

Contact guard station or management station if you don't remember the password

4) Opening the door with registered RF card (optional function)

- Put the RF card on the sensor positioned right below of camera lens to open the door. Door will be opened along with a message of 'oPEn' on FND.

[Reference for use]

1. If you try to open the door with unregistered RF card, it will be notified to guard station. Please try again after registering it at the guard station or management office.
2. If RF card still doesn't work after proper registering procedure, it is not usable card.

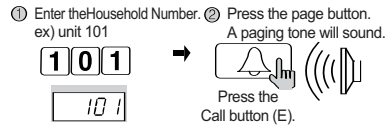

③ Wait for a reply

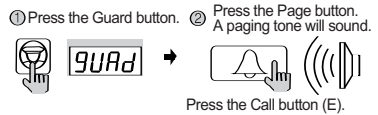

③ Wait for a reply

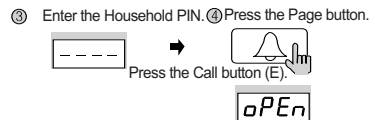
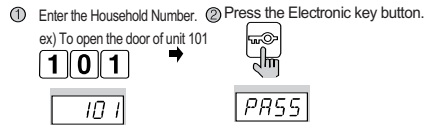



8. Installation

▶ Monitor installation

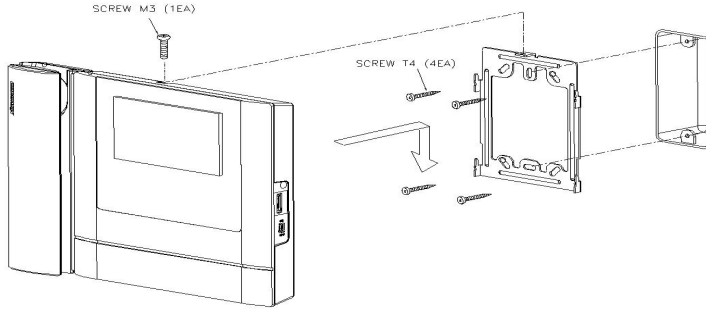

* Note

- Avoid installing the product in the area of direct sunlight.
- The position of the unit's body should fit the standard height range (Recommended height range is 1450 ~ 1500mm.)
- Avoid installing the product exposed to gas exposure, magnetic force, in humid temperatures, as it may damage the condition and performance of the product.



9. Wiring method

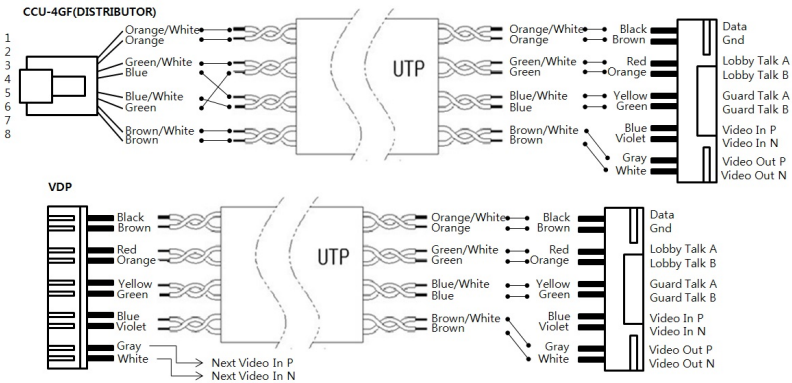

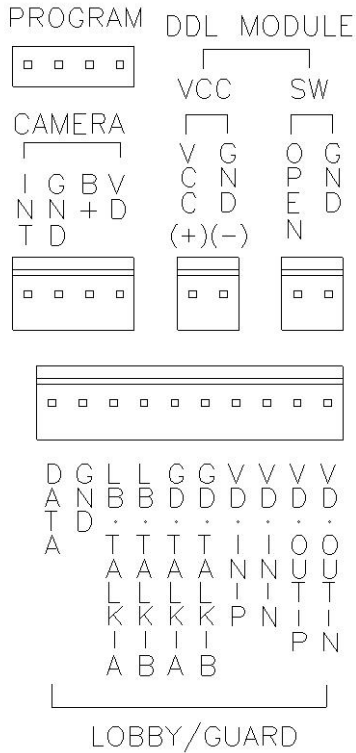

※ Cautions for wiring

- 1) If it is to be installed near high voltage line, please use coaxial cable for grounding
- 2) Keep the cable out of the sheath exposure to prevent to be shorted
- 3) Be sure to turn off the monitor before you connect the monitor with cameras.
- 4) Be careful of the polarity of the cable when you connect the monitor with cameras
- 5) Lobby Entrance
 - In case of connecting between lobby panel & monitor, please connect them VD/IN(DN), VD/OUT(UP) in order. Wire for transferring video signal between lobby & monitor



10. Component

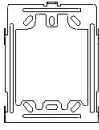

Bracket for wall mount



Manual

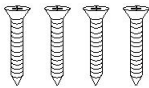

T4 × 18(4EA)
Screw for wall mount



M3 × 6(1EA)
Screw for body

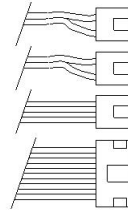

2P Connector(2EA)
4P Connector(1EA)
10P Connector(1EA)



11. Specifications

Spec	Model	CAV-43MHG / CAV-43MHG(M)
Transmission style		CAMERA :4 lines, LOBBY : 8 lines
Rated Voltage		100~240V~, 50/60Hz (FREE VOLTAGE)
Power consumption		MAX : 10W, Stand-by : 2W
Conversation		HAND-SET mode
Display		4.3" COLOR TFT-LCD (DIGITAL)
Calling sound		Entrance(Door/Lobby) : Electronic chime, Guard station : Melody
Talk duration		Standby : 30sec Conversation : 60sec, Guard station : 3min
Distance		Individual camera : 30m (Ø 0.5 - Line Impedance:3ohm) Common lobby : 300m (UTP), Guard station : 1Km
Working Temperature		0 ~+40°C (32°F ~ 104°F)
Dimension		243.0(W) X 168.0(H) X 30.0(D)

COMMAX

COMMAX Co.,Ltd.

513-11, Sangdaewon-dong, Jungwon-gu, Seongnam-si, Gyeonggi-do, Korea

Int'l Business Dept. Tel. : +82-31-7393-540~550 Fax. : +82-31-745-2133

Web site : www.commax.com

PM0243MHG010

Printed In Korea / 2017.01.104