

Since 1968

COMMAX
SmartHome & Security

User Manual

Fineview Video Phone CDV-43MH/CDV-43MH(M)



www.commax.com

COMMAX Co.,Ltd.



- Thank you for purchasing COMMAX products.
- Please carefully read this User's Guide (in particular, precautions for safety) before using a product and follow instructions to use a product exactly.
- The company is not responsible for any safety accidents caused by abnormal operation of the product.



Table of Contents

1. Warnings and Cautions.....	2
2. Part Names and Functions	3
3. Package Contents	3
4. Wiring and Connection Instructions.....	4
5. Installation	4
6. Operation	5
7. Settings	6
8. Specifications and Features.....	7









1. Warnings and caution











Please follow the things described below in order to prevent any danger or property damage.

 **Warning** It may cause a serious damage or injury if violated.

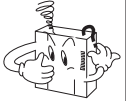
 **Caution** It may cause a minor damage or injury if violated.

-  Prohibition.
-  No disassembly
-  No touch
-  Must follow strictly.
-  Shows plugging out the power cord without an exception
-  Shows the warning and caution for an electric shock.
-  Shows the warning and caution for a fire.

Warning & Caution

Cleaning & Use	<p>Please don't disassemble, repair or rebuild this product arbitrarily (please contact the service center if a repair is needed).</p> <ul style="list-style-type: none"> It may cause an electric shock or fire.  	<p>If an abnormal sound, burning smell or smoke is coming out of the product, please plug out the power cable and contact a service center.</p> <ul style="list-style-type: none"> It may cause an electric shock or fire.   	<p>Please don't insert any metallic or burnable materials into the ventilation hole.</p> <ul style="list-style-type: none"> It may cause an electric shock or fire.    	<p>When cleaning the product, please rub it with a soft and dry cloth after plugging out the power cable. (Please don't use any chemical products such as wax, benzene, alcohol or cleanser.)</p>  
	<p>No disassembly</p>	<p>Electric shock Fire Unplug</p>	<p>Prohibition Electric shock Fire</p>	<p>Prohibition</p>

⚠ Warning & Caution

Power & Installation

Please don't use several products at the same time on one power socket.

- It may cause a fire due to an abnormal overheating.

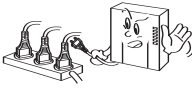

Please don't bend the power cable excessively or it may cause an electric shock.

- fire when using a damaged power cable.

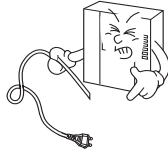

Please don't handle the power cable with a wet hand.

- It may cause an electric shock.

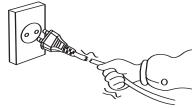

Please plug out the power cable from the socket when not using it for a long period of time.

- It may shorten the product lifespan or cause a fire.

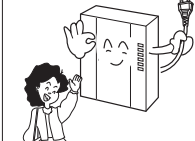

Please don't install the product in the place where there is much oil, smoke or humidity.

- It may cause an electric shock or fire.

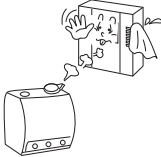

Please don't install the product with the lightning and thunder.

- It may cause an electric shock or fire.

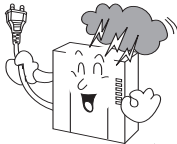

Please don't use and connect this product with other products with different rated voltage.

- It may cause a disorder or fire.

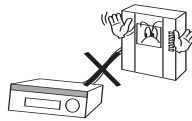

When installing the product that generates heat, please install the product away from the wall (10cm) for the ventilation.

- It may cause a fire due to the increased internal temperature.

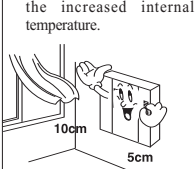

2. Parts Names

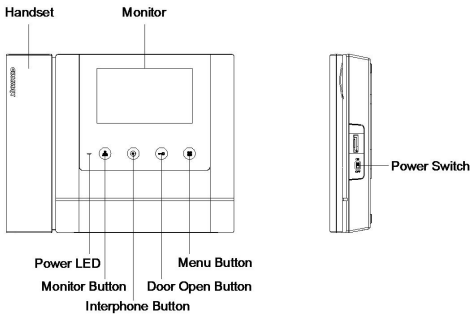

3. Package Contents

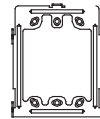

Wall bracket for monitor (1EA)



Monitor fixing screw (1EA)



Wall bracket mounting screw (4EA)

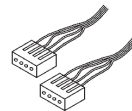

Connector (2EA)



User Manual (1EA)



4. Wiring and Connection Instructions

▷ Polarity of the camera connector

1. Red: Talk (Audio)
2. Blue: GND
3. Yellow: Power (+12V)
4. White: Video

▷ Polarity of interphone connector

1. Red: Talk (Audio)
2. Blue: GND
3. Yellow: Power (+14V)
4. White: Call signal

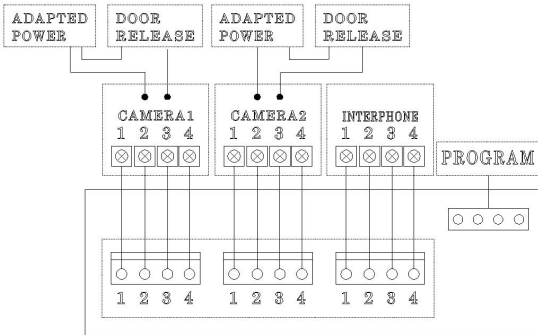

* Each device should be connected by separated cables.
If you use UTP CABLE[CAT.5] for CAMERA1 and CAMERA2, 2 lines of UTP cable are required.

* If you use UTP CABLE[CAT.5], connect 4 lines between monitor and interphone. the rest 4 lines to GND after connecting



5. Installation

▷ Monitor installation

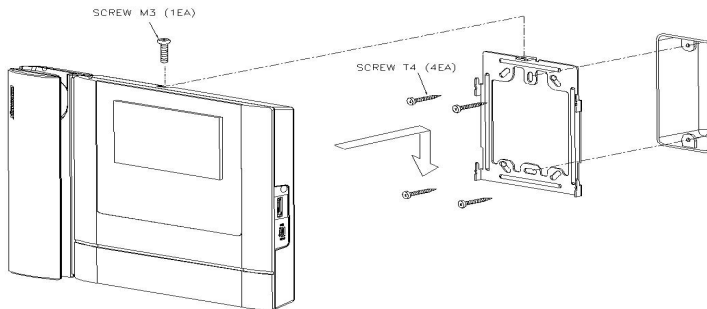

* Note

- Avoid installing the product in the area of direct sunlight.
- The position of the unit's body should fit the standard height range (Recommended height range is 1450 ~ 1500mm.)
- Avoid installing the product exposed to gas exposure, magnetic force, in humid temperatures, as it may damage the condition and performance of the product.



6. Operation

※ **Caution** : When you are holding the handset while the hook switch is off and someone may push the button of camera, you may lose your hearing because of high volume of calling sound.

1. Calling of visitor

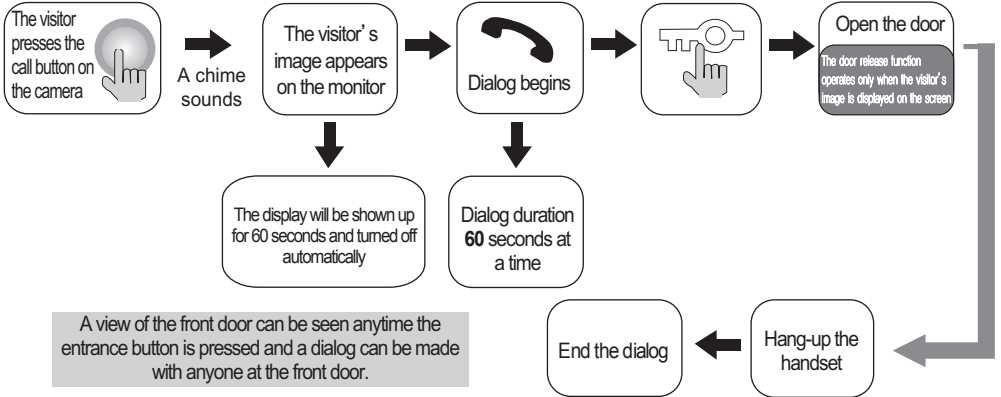

* In case of connecting two cameras

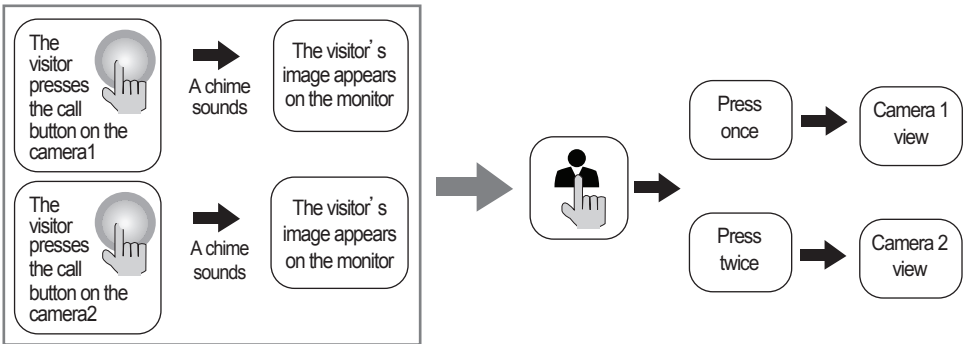

2. Communication with the optional Interphone

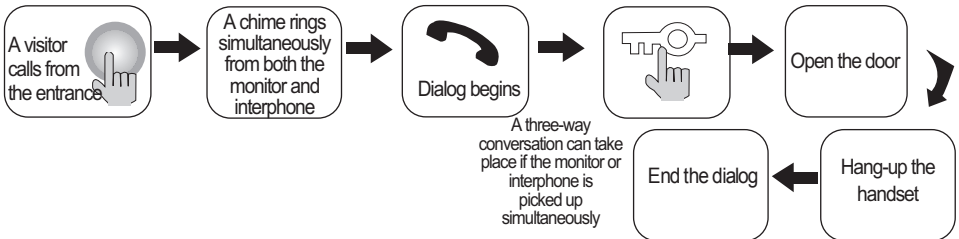

Dialog between the interphone and camera is possible only when the visitor's image is visible on the monitor screen.

3. Monitoring : function to see the image of visitor in the entrance.

(stand-by mode) Operation

- By pressing the Monitor button repeatedly, the monitor will work as following in order.

Camera 1 → (Camera 2) → OFF → Camera 1

(On talking mode)Operation

- By pressing Monitor button repeatedly, the monitor will work as following in order.

Camera1 → (Camera 2) → Camera 1 → (Camera 2)



7. Settings

- You can adjust DOOR VIDEO SET, UTILITY and check INFORMATION(model name &version) with (UP)△ / (DOWN)▽ button after pressing Menu button on the front of the product in video talk mode or stand-by monitoring.

- **Product settings need the following 4 buttons on the front of the product.**

- * Start Menu / Exit : MENU button * Select and in-put : SELECT (Interphone button)

- * Move up / Move right : △ / ▷ (Open button)

- * Move down / Move left : ▽ / ◁ (Monitoring button)

7-1. Screen setting (Brightness/Contrast/Color adjustment function)

Press the Menu button and access to DOOR VIDEO SET and enter the setting menu by pressing SELECT button.

(1) BRIGHTNESS : Adjusting Brightness of Screen

(2) CONTRAST : Adjusting Contrast of Screen

(3) COLOR : Adjusting Color of Screen

※ How to adjust

① Move to Menu you want to adjust with △/▽ button on the list of DOOR VIDEO SET

② Press SELECT button to choose an icon.

③ Adjust the set value with ◁/▷ button

④ To complete the set, press SELECT button.

(4) RESET : Initializing

※ How to Reset

① Move to RESET menu in DOOR VIDEO SET menu

② Press SELECT to enter the menu.

③ Select YES with ◁/▷ button

④ Press SELECT button.

(5) EXIT : Go back to setting mode

7-2. UTILITY(additional function)

Press the Menu button and access to Utility SET and enter the menu by pressing SELECT button.

(1) CHIME-BELL VOLUME : setting call sound level

① Move to CHIME-BELL VOLUME icon with △ / ▽ button in UTILITY Menu.

② Press SELECT to enter the menu.

③ Adjusting call level : 0(MUTE) ~ 3(MAX)

④ To complete the set, press SELECT button.

(2) SCREEN MODE : to set for screen ratio

- ① ZOOM: Zoon in(expansion) image maintaining actual ratio(4:3) is shown. (full of the screen)
- ② 4:3: Image of 4:3 ratio without expansion is shown.(This is actual ratio for camera)
- ③ WIDE: Full of the screen. Not actual ratio (4:3). Image is expanded according to LCD (WIDE LCD) ratio.

※ How to adjust

- ① Access to SCREEN MODE with Δ / ∇ button in UTILITY Menu
- ② Press SELECT button to enter the menu.
- ③ Adjust screen ratio value with \triangleleft / \triangleright button.
- ④ To complete the set, press SELECT button.

(3) EXIT : Go back to Setting menu

7-3. INFORMATION (The function to check Model name & Version)

In order to check the product information, press menu button and move to INFORMATION menu with \triangleleft / \triangleright button.

- (1) MODEL : You can check the model name.
- (2) VERSION : You can check the model version.
- (3) SYSTEM : SINGLE (FINE VIEW VIDEOPHONE)
- (4) TOUCH : You can check the touch-key version
- (5) VIDEO : You can check the video transmission formats(NTSC / PAL)
- (6) SOURCE : You can check the position of camera(DOOR) which is shown on the screen for now.

7-4. EXIT(Finish setting menu)



8. Specifications and Features

Power source	100-240V~, 50/60Hz(FREE VOLTAGE)
Power Consumption	Standby : 1.4W, Operating : 10W
Wiring	4 wires with door camera (Polarity), 4 wires with an Interphone (Polarity)
Screen Size	Color 4.3" TFT LCD
Communication	Simultaneous communication
Call Sound	From a door camera : Electric chime From an interphone : Beep sound
Time to display the screen	60 \pm 10sec
Distance from camera	28m(Φ 0.5) / 50m(Φ 0.65) / 70m(Φ 0.8)
Operating Temperature	0 ~ +40°C (32° F ~ 104° F)

Reference : Design and functions of the product are a subject of constant development as a pursuit of quality improvement

COMMAX

COMMAX Co.,Ltd.

513-11, Sangdaewon-dong, Jungwon-gu, Seongnam-si, Gyeonggi-do, Korea
Int'l Business Dept. Tel. : +82-31-7393-540~550 Fax. : +82-31-745-2133
Web site : www.commax.com

PM0743MH0010

Printed In Korea / 2017.04.104